

# ZENITH

MANUAL DE UTILIZARE  
USER MANUAL

RO / EN

**MULTUMIM!****THANK YOU!**

**RO** Multumim ca ati ales Zenith pentru a va mentine cool in bataliile digitale!

Pentru o functionare optima, va rugam sa urmati pasii din manualul de utilizare. Mai multe informatii despre produs sunt disponibile pe site-ul nostru, [WWW.AQIRYS.COM](http://WWW.AQIRYS.COM).

#COSMICFLOW #LUNARCOOL #STELLARWINDS

Welcome to the feel of AQIRYS®!

**EN** Thank you for choosing Zenith to keep you cool in digital battles!

For optimal performance, please follow the steps in the user manual. More product information is available on our website, [WWW.AQIRYS.COM](http://WWW.AQIRYS.COM).

#COSMICFLOW #LUNARCOOL #STELLARWINDS

Welcome to the feel of AQIRYS®!

**CUPRINS****SUMMARY**

Continut Pachet / Packing List.....	1
Prezentare / Overview .....	2
Instalare / Setup.....	3
Control si Functionalitati / Controls and Functions.....	4
Stand Multifunctional / Multi-Purpose Stand.....	5
Reglementari / Regulatory.....	6-7
Suport / Support.....	8

Continut Pachet

Packing List

1. Cooler pad laptop ZENITH	1. Laptop cooler pad ZENITH
2. Adaptor de Alimentare	2. Power Adapter
3. Ventilator USB	3. USB Fan
4. Stand Multifunctional	3. Multi-Purpose Stand

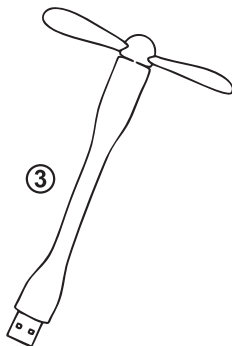
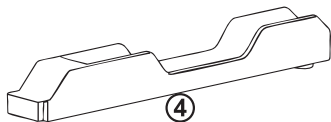
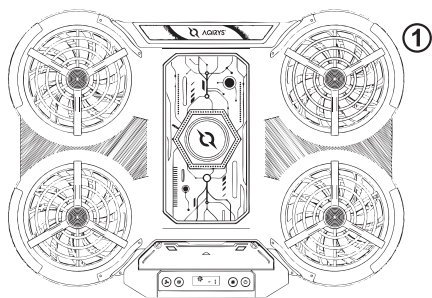



TOP

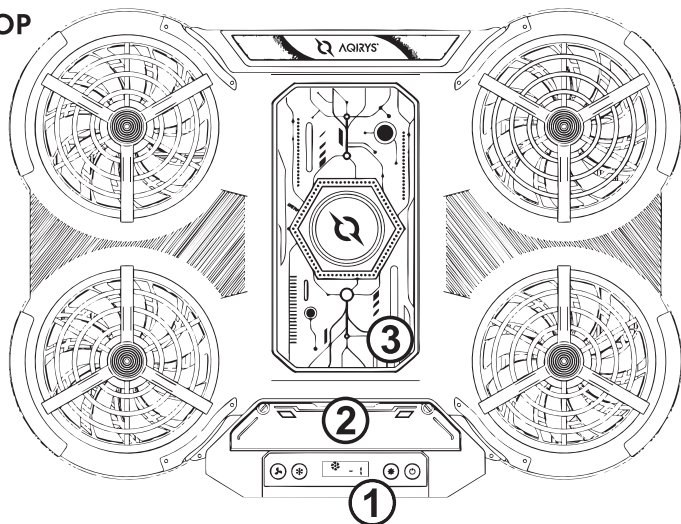

BACK



**RO**

1. Interfața de control
2. Suport Anti-Alunecare
3. Cooler Termoelectric
4. Port Alimentare Cooler Pad

**EN**

1. Control Interface
2. Anti-Slip Supports
3. Thermoelectric Cooler
4. Cooler Pad Power Input

## Instalare

## Setup

**RO**

Pentru a alimenta cooler pad-ul, urmați pașii de mai jos:

1. Conectați alimentatorul extern inclus în pachet (notat cu numărul 2 în conținut) la portul de alimentare a cooler pad-ului, marcată cu numărul 4 în prezentarea cooler pad-ului.
2. Introduceți celălalt capăt al alimentatorului extern într-o priză standard EU de 220V.

Asigurați-vă ca toate conexiunile sunt realizate corect pentru a permite alimentarea corespunzătoare a cooler pad-ului. **Utilizați exclusiv alimentatorul inclus în pachet pentru a evita eventualele probleme de funcționare.**

**EN**

To power the cooler pad, follow these steps:

1. Connect the external power adapter included in the package (labeled as number 2 in the contents) to the power input port of the cooler pad, marked as number 4 in the cooler pad presentation.
2. Plug the other end of the external power adapter into a standard EU 220V power outlet.

Ensure all connections are properly secured to provide adequate power to the cooler pad.

**Only use the included power adapter to avoid potential functionality issues.**

## Suport Anti-Alunecare

## Anti-Slip Support

**RO**

Pentru a poziționa corect laptopul pe cooler pad, este necesar să ridicați suportul anti-alunecare, marcat cu numărul 2 în prezentare. Acest suport va asigura stabilitatea laptopului, împiedicând alunecarea acestuia în timpul utilizării.

**EN**

To correctly position your laptop on the cooler pad, you need to raise the anti-slip support marked as number 2 in the presentation. This support will ensure your laptop's stability, preventing it from sliding during use.

Control si Functionalitati

Controls and Functions

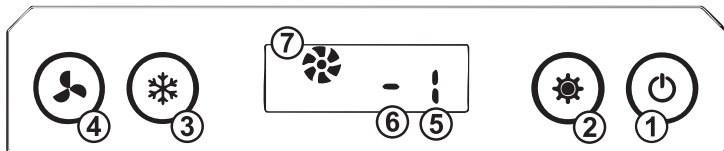

**RO**

1. Butonul de Pornire/Oprire: Acest buton permite activarea sau dezactivarea cooler pad-ului.
2. Butonul pentru Iluminare: Permite comutarea între diferite moduri de iluminare.
3. Butonul pentru Cooler-ul Thermoelectric: Acest buton activează și dezactivează cooler-ul thermoelectric.
4. Butonul pentru Viteza Ventilatoarelor: Acest buton permite ajustarea vitezei ventilatoarelor
5. Mod de Iluminare: Această secțiune a afisajului indica modul actual de iluminare selectat.
6. Nivelul Cooler-ului Thermoelectric: Afiseaza nivelul de răcire generat de cooler-ul thermoelectric.
7. Viteza Actuala a Ventilatoarelor: Aceasta zona a afisajului arata viteza curenta a ventilatoarelor.

**EN**

1. Power On/Off Button: This button allows you to turn the cooler pad on or off.
2. Lighting Button: Allows switching between different lighting modes.
3. Thermoelectric Cooler Button: This button activates and deactivates the thermoelectric cooler.
4. Fan Speed Button: This button allows you to adjust the fan speed.
5. Lighting Mode: This section of the display indicates the currently selected lighting mode.
6. Thermoelectric Cooler Level: Displays the cooling level generated by the thermoelectric cooler.
7. Current Fan Speed: This area of the display shows the current speed of the fans.

**Stand Multifunctional****Multi-Purpose Stand****RO**

Standul multifunctional, inclus separat in pachet si prezentat cu numarul 4 in lista continutului, poate fi montat cu usurinta urmand acesti pasi:

1. Identificati locasurile pentru montarea standului, situate la baza piciorului cooler pad-ului, pe laterale (stanga si dreapta).
2. Alegeti partea pe care doriti sa montati standul (stanga sau dreapta).
3. Introduceti standul in locasul ales, asigurandu-va ca este bine fixat pentru o stabilitate optima.

**EN**

The multifunctional stand, included separately in the package and listed as number 4 in the contents, can be easily installed by following these steps:

1. Locate the slots for mounting the stand, positioned at the base of the cooler pad's legs, on either side (left or right).
2. Choose the side where you want to mount the stand (left or right).
3. Insert the stand into the chosen slot, ensuring it is securely fixed for optimal stability.

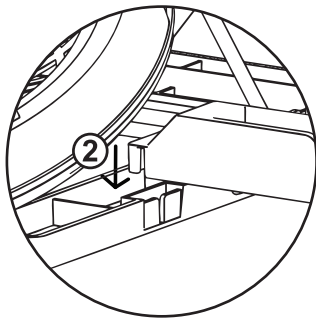
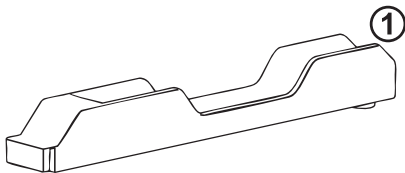



### REGLEMENTARI

### REGULATORY

- Unauthorized repairs or disassembly of the product will void the warranty and may cause its damage.
- This product is safe and complies to EU requirements. (compliant with directive EMC (2014/30/EU))
- This product is manufactured conforming with the European RoHS standard. (compliant with directive RoHS 2.0 (2015/863/EU))
- Using the WEEE symbol (the crossed-out bin) indicates that the electrical and electronic equipment inside the package can be recycled. When recycling waste properly, you protect the environment and people health. Segregated household waste collection, aids recycle materials and components used for the production of this device. For detailed information about recycling, please contact your retailer or a local authority.
- The batteries must not be disposed of with your other household waste; treat them in compliance with the local regulations or contact your local city office, your household waste disposal service, or the shop where you purchased the product.
- Reparatiile neautorizate sau dezasamblarea produsului duc la anularea garantiei si pot cauza deteriorarea lui.
- Produsul este unul sigur, conform cu cerintele UE. (respecta directiva EMC (2014/30/EU))
- Acest produs este fabricat in concordanta cu standardul european RoHS. (respecta directiva RoHS 2.0 (2015/863/EU))
- Utilizarea simbolului WEEE (pubelela taiata cu un X) indica faptul ca echipamentele electrice si electronice din interiorul ambalajului pot fi reciclate. Cand reciclati deseurile in mod corespunzator protejati mediul inconjurator. Colectarea selectiva ajuta la reciclarea materialelor si componentelor folosite la fabricarea acestui echipament. Pentru informatii detaliate privind reciclarea, va rugam sa contactati vanzatorul sau autoritatile locale.
- Bateriile nu trebuie aruncate impreuna cu celelalte deseuri menajere; tratati-le in conformitate cu reglementarile locale sau contactati biroul local al orasului, serviciul de eliminare a deseurilor menajere sau magazinul de unde ati achizitionat produsul.
- Les réparations non autorisées ou le désassemblage du produit portent à l'annulation de la garantie et peuvent causer son endommagement.
- Le produit est sûr, conformément aux exigences de l'UE. (respecte la directive CEM (2014/30 / UE))
- Ce produit est fabriqué conformément à la norme européenne RoHS. (respecte la directive RoHS 2.0 (2015/863/EU))
- L'utilisation du symbole DEEE (poubelle barrée d'une croix) indique que les équipements électriques et électroniques de l'intérieur de l'emballage peuvent être recyclés. Lorsque vous recyclez correctement les déchets, vous protégez l'environnement. La collecte sélective aide au recyclage des matériaux et des composants utilisés à la fabrication de cet équipement. Pour obtenir des informations détaillées sur le recyclage, veuillez contacter le vendeur ou les autorités locales.
- Les piles ne doivent pas être jetées avec les autres déchets ménagers ; traitez-les conformément aux réglementations locales ou contactez votre mairie, votre service d'élimination des déchets ménagers ou le magasin où vous avez acheté le produit.
- Nicht autorisierte Reparaturen oder Demontagen des Produkts führen zur Löschung der Garantie und möglicherweise zur Beschädigung des Produktes.
- Das Produkt ist nach den Anforderungen der EU sicher. (EMV Verordnung (2014/30/UE))
- Dieses Produkt wird gemäß der europäischen RoHS-Norm hergestellt. (RoHS Verordnung 2.0 (2015/863/EU))
- Die Verwendung des WEEE-Symbols (mit einem X durchgestrichene Tonne) zeigt an, dass die elektrischen und elektronischen Geräte in der Verpackung recycelt werden können. Wenn Sie Abfälle ordnungsgemäß recyceln, tragen Sie zum Umweltschutz bei. Die Abfalltrennung hilft beim Recycling von Materialien und Bauteilen, die bei der Herstellung dieser Geräte verwendet werden. Ausführliche Informationen zum Recycling erhalten Sie von Ihrem Händler oder den örtlichen Behörden.
- Die Batterien dürfen nicht mit dem Hausmüll entsorgt werden, sondern müssen gemäß den örtlichen Vorschriften behandelt werden. Wenden Sie sich an Ihre Stadtverwaltung, Ihren Hausmüllentsorgungsdienst oder an das Geschäft, in dem Sie das Produkt gekauft haben.
- Le riparazioni non autorizzate o lo smontaggio del prodotto portano all'annullamento della garanzia e possono causare il suo danneggiamento
- Il prodotto è sicuro, in conformità ai requisiti dell'UE (rispetta la direttiva EMC (2014/30 / UE))
- Questo prodotto è fabbricato in conformità alla norma europea RoHS. (rispetta la direttiva RoHS 2.0 (2015/863 / UE))
- L'uso del simbolo WEEE (cestino tagliato da una croce) indica che le apparecchiature elettriche ed elettroniche trovate all'interno della confezione possono essere riciclate. Quando riciclate i rifiuti in maniera adeguata, proteggete l'ambiente. La raccolta selettiva aiuta a riciclare i materiali e i componenti utilizzati per la fabbricazione di questa attrezzatura. Per informazioni dettagliate sul riciclaggio, contattare il venditore o le autorità locali.
- Le batterie non devono essere smaltite insieme agli altri rifiuti domestici; trattatele in conformità alle normative locali o contattate l'ufficio comunale, il servizio di smaltimento dei rifiuti domestici o il negozio dove avete acquistato il prodotto.
- Neoprávné opravy nebo demontáž výrobku vedou ke zrušení záruky a mohou způsobit jeho poškození.
- Jedná se o bezpečný výrobek v souladu s požadavky EU. (respektuje směrnici o EMC (2014/30/EU))
- Tento produkt je vyroben v souladu s evropskou normou RoHS. (je v souladu se směrnicí RoHS 2.0 (2015/863/EU))
- Použití symbolu WEEE (odpadkový koš, který je přeškrtnutý s X) naznačuje, že elektrická a elektronická zařízení z vnitřku balení jsou vhodná k recyklaci. Pokud řádně recyklujete odpady, chráníte životní prostředí. Selektivní sběr pomáhá recyklovat materiály a komponenty používané při výrobě tohoto zařízení. Za podrobné informace o recyklaci, kontaktujte prosím prodejce nebo místní úřady.
- Baterie se nesmí likvidovat společně s ostatním domovním odpadem; nakládejte s nimi v souladu s místními předpisy nebo se obraťte na místní obecní úřad, službu likvidace domovního odpadu nebo na obchod, kde jste výrobek zakoupili.



## REGLEMENTARI

## REGULATORY

- Neoprávnéné opravy alebo demontáž výrobku vedú k zrušeniu záruky a môžu spôsobiť jeho poškodenie.
- Jedná sa o bezpečný výrobok v súlade s požiadavkami EÚ. (Rešpektuje smernicu o EMC (2014/30/EU))
- Tento produkt je vyrobený v súlade s európskou normou RoHS. (splňa smernicu RoHS 2.0 (2015/863 / EU))
- Použitie symbolu WEEE (odpadkový kôš, ktorý je preškrtnutý s X) naznačuje, že elektrické a elektronické zariadenia z vnútra balenia sú vhodné na recykláciu. Ak riadne recyklujete odpad, chránite životné prostredie. Selektívny zber pomáha recyklovať materiály a komponenty používané pri výrobe tohto zariadenia. Za ďalšie informácie o recyklácii, kontaktujte prosím predajcu alebo miestne úrady.
- Batérie sa nesmú likvidovať spolu s ostatným domovým odpadom; zaobchádzajte s nimi v súlade s miestnymi predpismi alebo sa obráťte na miestny mestský úrad, službu likvidácie domového odpadu alebo obchod, v ktorom ste výrobok zakúpili.
- Neovláčené opravy alebo otváranie výrobku vedú k anulovaniu garancie a môžu viesť do oštiepenia ureada.
- Proizvod jeste bezbedan, u skladu sa zahtevima EU. (poštuj direktivu EMC (2014/30/EU).
- Ovaj proizvod proizveden je u skladu sa evropskim standardom ROHS (odnosno direktiva ROHS 2.0. (2015/863/EU).
- Uputreba simbola WEEE (kanta isečena sa X) pokazuje činjenicu da sve električne i elektrotehničke opreme iz ambalaže mogu biti reciklirani. Kada vršite reciklažu otpada na odgovarajući način štite životnu sredinu. Selektivna kolekcija pomaže u reciklažu materijala i komponenta upotrebljenih u proizvodnji opreme. Za detaljne informacije u odnosu na reciklažu, molimo vas da stupite u kontaktu sa vašim proizvođačem ili lokalnim vlastima.
- Baterije se ne smeju odlagati sa ostalim kućnim otpadom; postupaite sa njima u skladu sa lokalnim propisima ili se obratite lokalnoj gradskoj kancelariji, službi za odlaganje kućnog otpada ili prodavnici u kojoj ste kupili proizvod.
- Μη εξουσιοδοτημένες επιδιορθώσεις ή αποσυναρμολόγηση του προϊόντος επιφέρουν ακύρωση της εγγύησης και μπορούν να προκαλέσουν την αλλοίωση του.
- Το προϊόν είναι ασφαλέ, σε συμμόρφωση με τις απαιτήσεις της Ε.Ε. (συγκεκριμένα την οδηγία EMC (2014/30/EU)
- Αυτό το προϊόν κατασκευάζεται σύμφωνα με το ευρωπαϊκό πρότυπο RoHS. (συγκεκριμένα την οδηγία RoHS 2.0 (2015/863/EU).
- Η χρήση του συμβόλου WEEE ( διαγραμμένος κάδος απορριμμάτων με ένα X) υποδεικνύει πως ο ηλεκτρικός και ηλεκτρονικός εξοπλισμός του εσωτερικού του αμπαλαζή μπορούν να ανακυκλωθούν. Όταν ανακυκλώνεται τα αποβέκτης με αποβέκτο τρόπο προστατεύεται τον περιβάλλον. Η ηλεκτρική συλλογή βοηθά στην ανακύκλωση των υλικών και εξαρτημάτων που χρησιμοποιούνται στην παραγωγή αυτού του εξοπλισμού. Για λεπτομερείς πληροφορίες σχετικά με την ανακύκλωση, παρακαλούμε να επικοινωνήσετε με τον πωλητή ή τις τοπικές αρχές.
- Οι μπαταρίες δεν πρέπει να απορριπτονται μαζί με τα υπόλοιπα οικιακά απορρίμματα. Αντιμετωπίστε τις σύμφωνα με τους τοπικούς κανονισμούς ή επικοινωνήστε με το τοπικό δημόσιο γραφείο, την υπηρεσία απόρριψης οικιακών απορριμμάτων ή το κατάστημα από το οποίο αγοράσατε το προϊόν.
- Неотризираните ремонтни работи или разглобяването на продукта водят до нищожество на гарацията и могат да доведат до неговата повреда.
- Продуктът е само една бройка, в съответствие с изискванията на ЕС. (Спазва разпореденията на Директивата EMC (2014/30/EC))
- Този продукт е произведен в съответствие с европейския стандарт RoHS. (Съответстваща Директива RoHS 2.0 (2015/863/EC))
- Отбелязаното на символа WEEE (зачеркната с X кофа за отпадъци) посочва факта, че електрическите и електронните устройства в опаковката могат да се рециклират. При надлежно рециклиране, опазвате околната среда. Разделното събиране на отпадъците помага за рециклирането на употребяваните материали и съставки за изработване на това устройство. За подробни информации относно рециклирането, молим Ви да се свържете с продавача на устройството или местните власти.
- Батериите не трябва да се извървят заедно с другите битови отпадъци; третирайте ги в съответствие с местните разпоредби или се обърнете към местната общинска администрация, службата за извървяне на битови отпадъци или към магазина, в който сте закупили продукта.
- Nieautoryzowane naprawy lub demontaż produktu spowodują utratę gwarancji i mogą spowodować jego uszkodzenie.
- Produkt bezpieczny, zgodny z wymogami UE. (przestrzegaj dyrektywy EMC (2014/30 / UE))
- Ten produkt został wyprodukowany zgodnie z europejską normą RoHS. (odpowiednio dyrektywę RoHS 2.0 (2015/863 / UE)
- Użycie symbolu WEEE (kosz na śmieci z X) oznacza, że sprzęt elektryczny i elektroniczny wewnątrz opakowania można poddać recyklingowi. Poprzez prawidłowy recykling odpadów chronisz środowisko. Selektywna zbiórka pomaga w recyklingu materiałów i komponentów użytych do produkcji tego sprzętu. Aby uzyskać szczegółowe informacje dotyczące recyklingu, skontaktuj się ze sprzedawcą lub lokalnymi władzami.
- Baterie nie mogą być wyrzucane z innymi odpadami domowymi; należy je traktować zgodnie z lokalnymi przepisami lub skontaktować się z lokalnym urzędem miasta, służbą utylizacji odpadów domowych lub sklepem, w którym zakupiono produkt.
- A termék nem szakszerű javítása vagy a termék alkatrészekre való bontása a garancia eltérését jelenti és ugyanakkor a termék sérülését is előidézheti.
- A termék biztonságos, gyártása EU-s normáknak megfelelő. (EMC/2014/30/EU)
- A termék gyártása az európai RoHS standard normatíváknak megfelelő (RoHS 2.0 (2015/863/EU)
- A WEEE szimbólum (áthúzott kuka szimbólum) jelzi, hogy a csomagban található elektromos és elektronikus alkatrészek újrahasznosíthatók. A hulladék megfelelő újrahasznosításával védi környezetét. A selektív hulladékgyűjtéssel hozzájárul ezen termék gyártásához használt anyagok és alkatrészek újrahasznosításához. Bővebb tájékoztatásért kérjük igényelje a részleteket a forgalmazóval vagy a helyhatósági szervek képviselőitől.
- Az akkumulátorokat nem szabad a többi háztartási hulladékkal együtt ártalmatlanítani; kezelje azokat a helyi előírásoknak megfelelően, vagy forduljon a helyi városi hivatalhoz, a háztartási hulladékezelőhöz vagy ahhoz az üzlethez, ahol a terméket vásárolta.



SUPPORT

SUPPORT

**RO** Daca intampinati erori sau orice alte probleme in utilizarea produsului nu ezitati sa ne contactati.

**EN** If you encounter errors or any other problems with the product don't hesitate to contact us.



[support@aqirys.com](mailto:support@aqirys.com)



**SCAN ME**  
(product page)

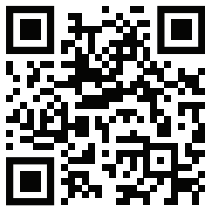

**SCAN ME**  
(Follow us)

© AQIRYS®. All rights reserved. AQIRYS® name and logo and all other related products, service names, and design marks are trademarks or registered trademarks of PC-coolers SRL. All other brand names and trademarks are the property of their respective owners. Specifications and design are subject to change without notice due to product improvements.